

Indoor Unit
ASWG09LMCB
ASWG12LMCB

Outdoor Unit
AOWG09LMCB
AOWG12LMCB

Contents

Safety Precautions	En-1
Indoor Unit Overview and Operations	En-2
Remote Controller Overview and Operations.....	En-3
Care and Cleaning.....	En-5
Troubleshooting.....	En-7

Before using this product, read these instructions thoroughly and keep this manual for future reference.

Safety Precautions

To prevent personal injury, or property damage, read this section carefully before you use this product, and be sure to comply following safety precautions.

Incorrect operation due to failure to follow the instructions may cause harm or damage, the seriousness of which is classified as follows:

WARNING

This mark warns of death or serious injury.

This mark denotes an action that is PROHIBITED.

CAUTION

This mark warns of injury or damage to property.

This mark denotes an action that is COMPULSORY.

WARNING

- This unit contains no user-serviceable parts. Always consult authorized service personnel for repairing, installation, and relocation of this product. Improper installation or handling will cause leakage, electric shock, or fire.
- In the event of a malfunction such as burning smell, immediately stop operation of the air conditioner, and disconnect all the power supply by turning off the electrical breaker or disconnecting the power plug. Then consult authorized service personnel.
- Take care not to damage the power supply cable. If it is damaged, it should only be replaced by authorized service personnel.
- In the event of refrigerant leakage, be sure to keep away from fire or any flammables, and consult authorized service personnel.
- If you see lightning or hear thunder, there might be a lightning strike. To prevent electric shock hazard, turn off the air conditioner by using the remote controller, and do not touch the unit or the power plug during thunderstorm.
- Do not install the unit in area filled with mineral oil such as a factory or area containing a large amount of splashed oil or steam such as a kitchen.
- Do not start or stop the operation of this product by inserting or pulling out the power plug, or by turning on or off the circuit breaker.
- Do not use inflammable gases near the unit.
- Do not expose yourself directly to the cooling airflow for many hours.
- Do not insert your fingers or any other objects into outlet port, open panel, or intake grille.
- Do not operate with wet hands.

CAUTION

- Provide occasional ventilation during use.
- Always operate the unit with air filters installed.
- Ensure that any electronic equipment is at least 1 meter away from either the indoor unit or outdoor unit.
- Unplug the power supply cable when not using the indoor unit for an extended period.
- After long period of use, check whether the installation stand does not deteriorate to prevent the unit from falling down.
- The airflow direction and the room temperature should be carefully considered when you use this product in a room with infants, children, elderly or sick persons.
- This appliance is not intended for use by persons (including children) with reduced physical, sensory or mental capabilities, or lack of experience and knowledge, unless they have been given supervision or instruction concerning use of the appliance by a person responsible for their safety. Children should be supervised to ensure that they do not play with the appliance.
- Do not direct the airflow at fireplaces or heating apparatus.
- Do not block or cover the intake grille and the outlet port.
- Do not apply any heavy pressure to radiator fins.
- Do not climb on, place objects on, or hang objects from the unit.
- Do not place vase or water container on the unit.
- Do not place any other electrical products or household belongings under indoor unit or outdoor unit. Dripping condensation from the unit might get them wet, and may cause damage or malfunction of your property.
- Do not expose the unit directly to water.
- Do not use this product for preservation of food, plants, animals, precision equipment, art work, or other objects. This may cause quality deterioration of those items.
- Do not expose animals or plants to the direct airflow.
- Do not drink the drainage from the air conditioner.
- Do not pull the power supply cable to disconnect the plug.
- Do not touch the aluminum fins of heat exchanger built-in the indoor or outdoor unit to avoid personal injury when you install or maintain the unit.



Indoor Unit Overview and Operations

1 Intake grille

Before starting operation, make sure that the intake grille has been shut completely. Incomplete closing might have an effect on the proper working or performance of the product.

2 Manual AUTO button

Use when you lost the remote controller or remote control malfunction occurs.

Status	Action	Mode or operation
In operation	Press more than 3 seconds.	Stop
Stopping	Press more than 3 seconds and less than 10 seconds.	AUTO
	Press more than 10 seconds. (Only for servicing.*)	Forced cooling
After cleaning	Press less than 3 seconds.	Filter indicator reset

*:To stop forced cooling, press this button or START/STOP button on the remote controller.

3 Front panel

4 Vertical airflow direction louver

Each time you press SET button on the remote controller, the angle of the vertical airflow direction louver moves as follows:

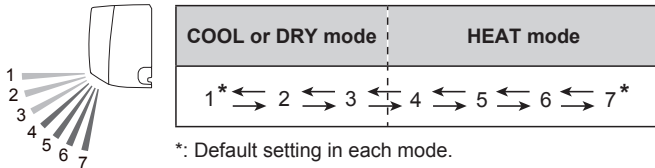

- Do not adjust by hand.
- At the beginning of AUTO or HEAT mode, they may stay position 1 for a while for adjustment.
- If you set the angle to position 4–7 for more than 30 minutes in COOL or DRY mode, they automatically return to position 3. In COOL or DRY mode, if the angle is set to position 4–7 for many hours, condensation may be formed, and the drips may wet your property.

5 Power diffuser

In conjunction with movement of the vertical airflow direction louver, the angle of the power diffuser moves as follows:

Vertical airflow direction louver	1 ↔ 2 ↔ 3 ↔ 4 ↔ 5 ↔ 6 ↔ 7
Power diffuser	1 ↔ 2 ↔ 3 ↔ 4

- In SWING operation, power diffuser does not move.

6 Drain hose

7 Remote control signal receiver

CAUTION

- For appropriate signal transmission between remote controller and the indoor unit, keep the signal receiver away from following items:
 - Direct sunlight or other strong light
 - Flat-panel television screen

In rooms with instantaneous fluorescent lights, such as inverter type ones, the signal may not be transmitted properly. In such a case, consult the store that you purchased the product.

8 ECONOMY indicator (green)

Lights in ECONOMY operation.

9 TIMER indicator (orange)

Lights in TIMER operation, and blinks slowly when the timer setting error is detected.

As for the timer setting error, refer to "Auto-restart function" on page 4.

10 OPERATION indicator (green)

Lights in normal operation, and blinks slowly in automatic defrosting operation.

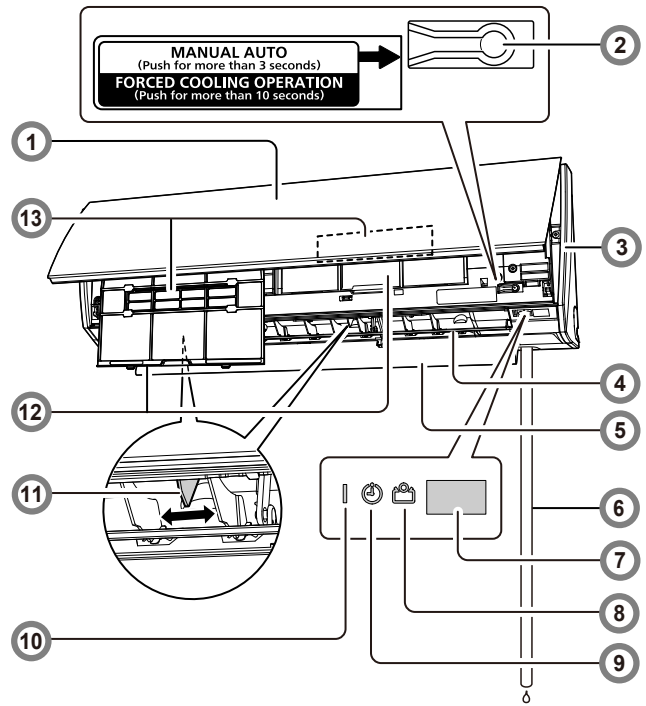

11 Horizontal airflow direction louvers

CAUTION

- Before you adjust the horizontal airflow direction, make sure that the vertical airflow direction louver has been stopped completely.

Adjust two knobs by hand.

12 Air filter

See page 5

Easy-to-care air filters resist mildew growth.

13 Air cleaning filters

See page 6

Purify or deodorize the air, and provide fresh airflow.

Indoor unit accessories

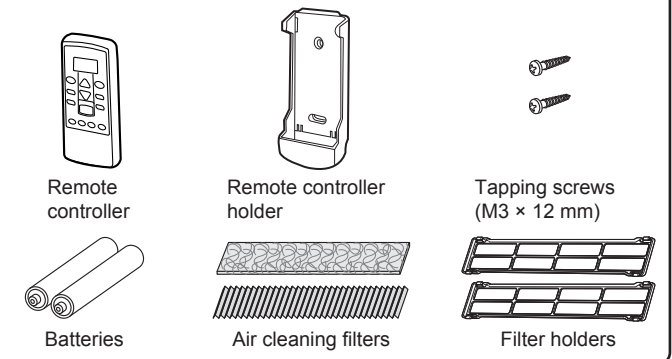

WARNING

- Take care to prevent infants and young children from accidentally swallowing the batteries.

Remote controller holder installation

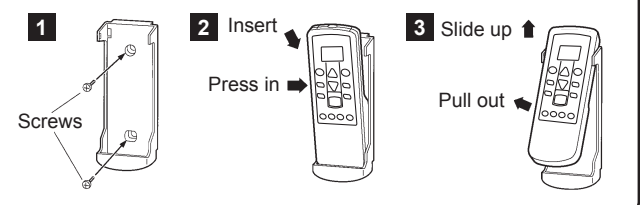

Remote Controller Overview and Operations

CAUTION

- !** To prevent malfunction or damage of the remote controller:
 - Place remote controller at where will not be exposed to direct sunlight or excessive heat.
 - Remove batteries if the product is not going to be used for an extended period.
 - Exhausted batteries must be removed immediately, and be disposed according to the local laws and regulations of your region.
- !** If leaking battery fluid comes in contact with your skin, eyes, or mouth, immediately rinse with plenty of clean water, and consult your physician.
- Obstacles such as a curtain or wall between the remote controller and the indoor unit may affect the appropriate signal transmission.
- ⊘** Do not apply strong shocks to the remote controller.
- Do not pour water on the remote controller.
- Do not attempt to recharge dry batteries.

Battery (AAA/R03/LR03 × 2) loading

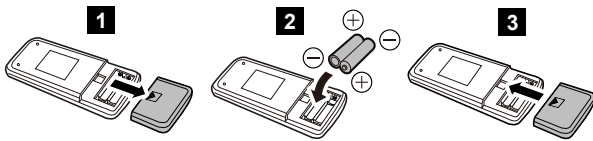

Notes:

- Use specified type of battery only.
- Do not use new battery and used battery together.
- Batteries can be used about 1 year in ordinary use.
- If the remote control range noticeably got shorten, replace the batteries, and press RESET button.

You can quickly start the operation with following 3 steps:

1 START/STOP button

2 MODE button

Switches operation mode in following order.



Notes in HEAT mode:

- At the beginning of the operation, the indoor unit operates at very low fan speed for about 3–5 minutes for preparation, and then switches to the selected fan speed.
- Automatic defrosting operation overrides the heating operation when it is necessary.

3 SET TEMP. (temperature) buttons

Set desired temperature.

Temperature setting range	
AUTO	18–30 °C
COOL/DRY	18–30 °C
HEAT	16–30 °C

*:Temperature control is not available in FAN mode.

4 FAN button

Controls the fan speed.



- When AUTO is selected, the fan speed is automatically adjusted according to the operation mode.

5 SET button

Adjusts the vertical airflow direction.

6 SWING button

- Starts or stops automatic swing of the vertical airflow direction louver.
- Each time you press the button, the vertical airflow direction louver swings as follows:

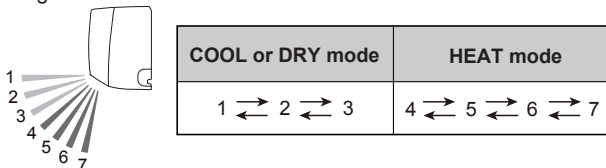

Note:

- SWING operation may stop temporarily when the fan in the unit is rotating at very low speed or stopping.
- In FAN mode, either of swing direction 1 ↔ 3 or 4 ↔ 7 is performed in accordance with the vertical airflow direction previously set before you start the SWING operation.

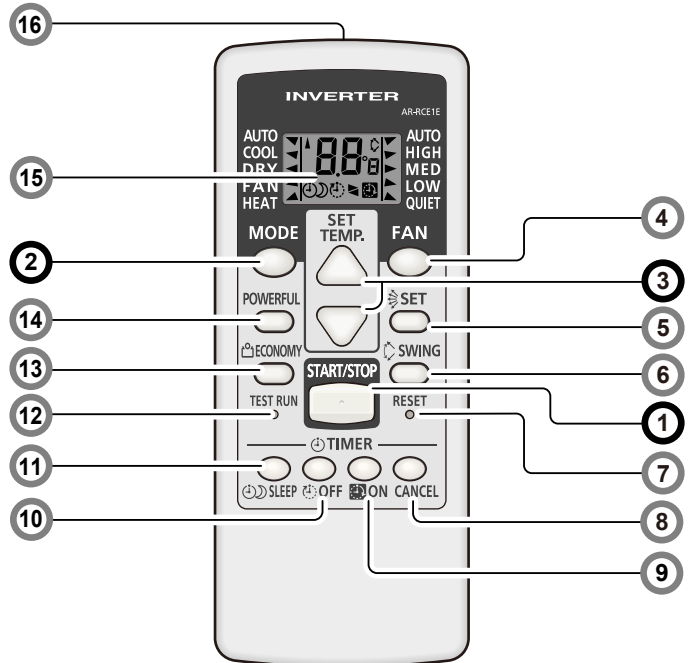

7 RESET button

When you press the RESET button, press it gently by using the tip of a ballpoint pen or other small object in correct direction as shown in this figure.



8 TIMER CANCEL button

Cancels the set timer.

9 ON TIMER button

Each time you press the button, the time changes as follows:



- Set the time while the indicator on the remote controller display is blinking.

10 OFF TIMER button

Each time you press the button, the time changes as follows:



- Set the time while the indicator on the remote controller display is blinking.



*: The setting must be done within about 3 seconds during the indicator stays solid.
 †: The button is controllable only when the air conditioner is on.

(continued)

Remote Controller Overview and Operations

Program timer (combined use of the ON timer and the OFF timer)

You can set an integrated ON-OFF or OFF-ON timer as follows:

	<p>Set the ON timer first. Then set the OFF timer by the air conditioner starts operation controlled with the ON timer earlier set.</p>
	<p>Set the OFF timer first. Then set the ON timer by the air conditioner stops operation controlled with the OFF timer earlier set.</p>

The timer that is set later starts counting down after the counting down of the preceding timer is finished.

Note:

If you change the setting value for the timer after the program timer is set, the counting down of the timer will be reset at that moment.

11 SLEEP TIMER button *

Each time you press the button, the time changes as follows:



- Set the time while the  indicator on the remote controller display is blinking.
- To repeat the timer, press the button when the indicator is not displayed.

To help you to fall asleep comfortably and prevent excessive warming or cooling in sleep, the SLEEP timer controls the temperature setting automatically in accordance with the set time shown as follows. The air conditioner completely turns off after the set time has elapsed.

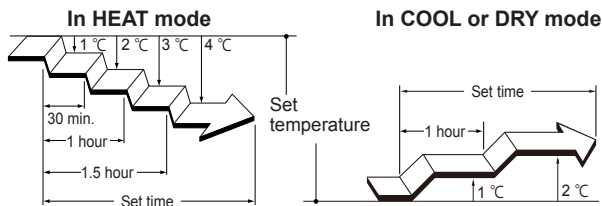

Note for TIMER settings:

Any interruption of the power supply, such as a blackout or cutting off of a circuit breaker, makes the set internal clock go wrong. In such a case, the TIMER indicator on the indoor unit blinks, and you need to readjust the setting.

12 TEST RUN button *

Only used for the initial test in the unit installation. Do not press this button under normal use because it will cause incorrect operation.

- During the test run, the OPERATION indicator and the TIMER indicator blink simultaneously.
- To quit the test run that is started unintentionally, you need to turn off the air conditioner by pressing the START/STOP button.

13 ECONOMY button *

Starts ECONOMY operation that saves more electricity consumption than the other operations with a conservative adjustment of the room temperature.

When you press the button, the ECONOMY indicator on the indoor unit turns on.

- In COOL mode, the room temperature will be adjusted at a few degree higher than the defined temperature.
In HEAT mode, the room temperature will be adjusted at a few degree lower than the defined temperature.
- Especially in COOL mode, you can have improved dehumidification without significantly lowering the room temperature.

Notes:

- In COOL or HEAT mode, the maximum output of this operation is approximately 70 % of usual air conditioning operation.
- This operation cannot be performed during temperature monitoring by AUTO mode.

14 POWERFUL button *

Starts POWERFUL operation that enables quick cooling down or warming up of the room. When you press the button to start the POWERFUL operation, the indoor unit emits 3 short beeps.

POWERFUL operation is automatically turned off in the following situations:

- Adjusted room temperature reached to the defined temperature in temperature setting in COOL, DRY, or HEAT mode.
- 20 minutes have passed after finishing the POWERFUL operation mode setting.

It is not turned off automatically during setting of the POWERFUL operation.

Notes:

- The airflow direction and the fan speed are controlled automatically.
- This operation cannot be performed simultaneously with ECONOMY operation.

To return to normal operation, press the button again. Then the indoor unit emits 2 short beeps.

15 Remote controller display

In this section, all the possible indicators are displayed for description. In actual operation, the display is linked with the button operation, and only shows the necessary indicators for each setting.

16 Signal transmitter

Aim to signal receiver of the indoor unit properly.

- Signal transmit indicator  on the remote controller display shows that signal from the remote controller is being transmitted.
- Operating range is approximately 7 m.
- You will hear a beep if the transmitted signal has been sent properly. If there is no beep, press the button on the remote controller again.

Automatic defrosting operation

When outdoor temperature is very low with high humidity, frost may form on the outdoor unit during the heating operation, and it could reduce the operating performance of the product.

For frost protection, a microcomputer-controlled automatic defrost function is equipped in this air conditioner.

If frost forms, the air conditioner will temporarily stop, and defrost circuit will operate briefly (maximum of 15 minutes.) OPERATION indicator on the indoor unit blinks during this operation.

If frost forms on the outdoor unit after the heating operation, the outdoor unit will stop automatically after it operates for a few minutes. Then the automatic defrosting operation starts.

Auto-restart function

In event of power interruption such as a blackout, the air conditioner stops once. But it restarts automatically and performs previous operation when the power supply is resumed.

If any power interruption occurs after the timer is set, counting down of the timer will be reset.

After the power supply is resumed, the TIMER indicator on the indoor unit blinks to notify you that there has been a timer fault. In such a case, reset the timer for your opportune time.

Malfunctions caused by other electrical devices:

Use of other electrical appliances such as an electric shaver or nearby use of a wireless radio transmitter may cause the malfunction of the air conditioner.

If you encounter such a malfunction, turn off the circuit breaker once. Then turn it on again, and resume operation by using the remote controller.

Care and Cleaning

⚠ CAUTION

- ❗ Before cleaning the indoor unit, be sure to turn it off and all the power supply has been disconnected.
- ❗ Before starting operation, make sure that the intake grille has been shut completely. Incomplete closing of the intake grille might have an effect on the proper working or performance of the air conditioner.
- ⊘ Do not touch the aluminum fins of heat exchanger built-in the indoor unit to avoid personal injury when you maintain the unit.
- ⊘ Do not expose the indoor unit to liquid insecticides or hair sprays.
- ⊘ Do not stand on slippery, uneven or unstable surfaces when you maintain the unit.

Daily care

When cleaning the indoor unit body, mind the following:

- Do not use water hotter than 40 °C.
- Do not use scouring cleanser, volatile solvents such as benzene or thinner.
- Wipe the unit gently by using soft cloth.

Cleaning the intake grille

- 1 Open the intake grille in direction of the arrow **a**. While gently pressing the left and right mounting shafts of the intake grille outward **b**, remove the intake grille in direction of the arrow **c**.

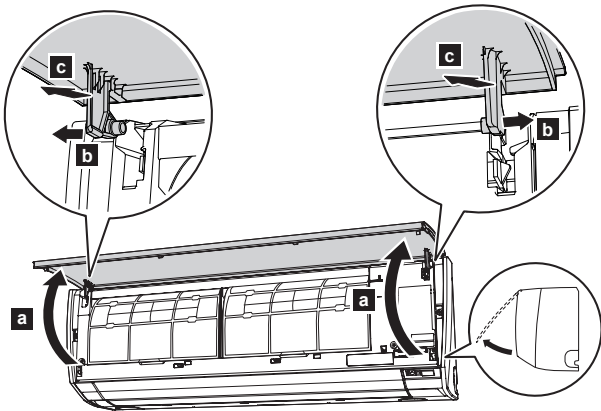

- 2 Wash the intake grille gently with water or wipe it gently with a soft cloth moisten with warm water. Then wipe it with a dry and soft cloth.
- 3 While holding the grille horizontal, set the left and right mounting shafts into the pillow blocks at the top of the panel **a**. To latch each shaft properly, insert the shaft until it snaps. Then close the intake grille **b**.

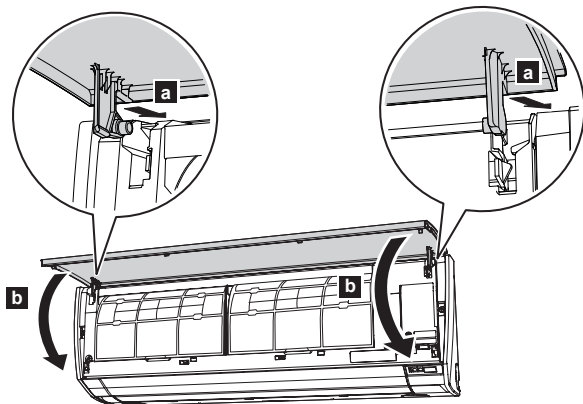

- 4 Press 4 places on the intake grille to close it completely.

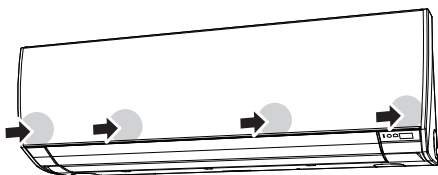

Cleaning the air filters

Mind that you have a periodical cleaning of the air filters to prevent reducing the operation efficiency of the product.

Using of clogged air filter with dust will lower the product performance, and may cause airflow reduction or increase of operating noise.

Clean the air filters once every 2 weeks under normal use.

- 1 Open the intake grille. (Refer to **a** of step 1 in "Cleaning the intake grille".)
- 2 While holding the intake grille with your hand, pull up the handle **a** of the filter in direction of the arrow and release the 2 claws **b**. Then pull the filter out with gently sliding it downward **c**.

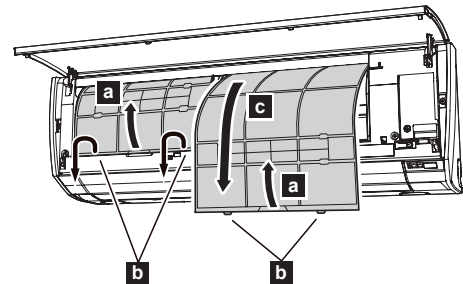

- 3 Filter holder and air cleaning filter are attached on the rear side of the air filter. Remove them from the air filter by unlatching each corner of the filter holder **d**.

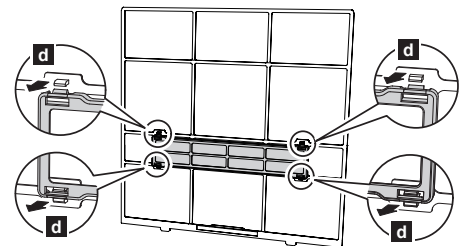

- 4 Remove dust by using a vacuum cleaner or by washing the filter. When you wash the filter, use neutral household detergent and warm water. After rinse the filter well, dry it thoroughly in a shaded place before you reinstall it.
- 5 Attach the air cleaning filter and the filter holder to each air filter.
- 6 Attach the air filter with aligning both side of the filter with the front panel, and push in the filter fully.

Note:

Make sure that 2 claws are firmly snapped to the guide holes on the panel.

- 7 Close the intake grille firmly. (Refer to step 4 in "Cleaning the intake grille".)

Care and Cleaning

Replacing the air cleaning filter

- 1 Remove the air filter. (Refer to step 1 in "Replacing the air filter".)
- 2 Release 2 latches **a** of the filter holder, and turn over the holder in direction of arrow **b**.
Remove the soiled air cleaning filter **c**.

Note:

Air cleaning filter is attached on each air filter.

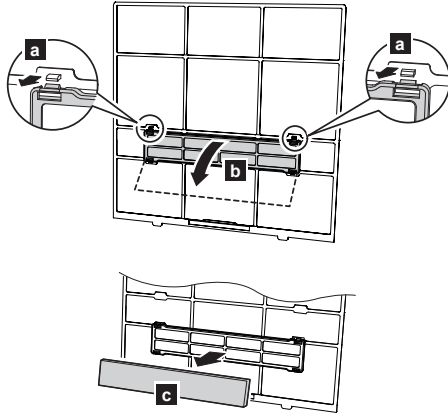

- 3 Attach new or maintained air cleaning filter **d** to the filter holder. New air cleaning filter can be attached to either of the right holder or the left holder.

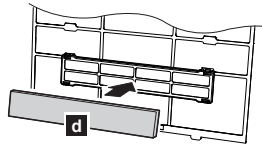

- 4 Latch 2 corners of the filter holder **e** to the air filter firmly.

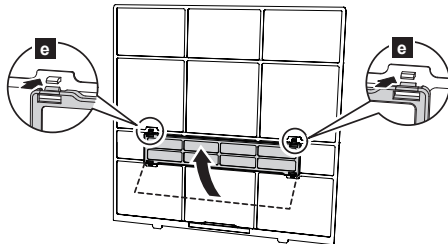

- 5 Reinstall the air filter. (Refer to step 6 in "Cleaning the air filter".)
- 6 Close the intake grille firmly. (Refer to step 4 in "Cleaning the intake grille".)

Following 2 types of air cleaning filters are used in this product. When you replace them, purchase dedicated air cleaning filters for this product.

APPLE-CATECHIN FILTER: UTR-FA16



(1 sheet)

With using static electricity, purifies the air by removing fine particles or dust such as tobacco smoke or plant pollen.

- This filter is disposable. Do not wash or reuse it.
- Once you open the package, use it as soon as possible. The cleaning effect is reduced if the filter is left the package opened.
- Replace the filter once every 3 months under normal use.
- With setting the fan speed high, the air cleaning effect increases.

ION DEODORIZATION FILTER (light blue): UTR-FA16-2

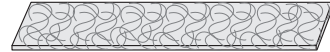

(Light blue, 1 sheet)

Contained super micro-ceramic particles produce negative air ions, that is considered to have deodorizing effect, absorb and reduce room smell.

- To maintain the deodorizing effect, clean the filter once every 3 months as follows:
 1. Remove the ion deodorization filter.
 2. Flush the filter with high-pressure hot water until the surface of the filter is covered with water.
 3. Wash the filter gently with diluent neutral detergent. Do not wash it by wringing or rubbing to prevent reducing the deodorizing effect by damage.
 4. Rinse the filter well with water flow.
 5. Dry the filter thoroughly in shaded place.
 6. Reinstall the ion deodorization filter to the indoor unit.
- Replace the filter once every 3 years under normal use.

After extended non-use of the unit

If you have shut down the indoor unit for 1 month or more, perform the FAN operation for half a day to dry the internal parts thoroughly before you perform normal operation.

Additional inspection

After long period of use, accumulated dust inside the indoor unit may reduce the product performance even if you have maintained the unit with instructed daily care or cleaning procedures written in this manual.

In such a case, the product inspection is recommended.

For more information, consult authorized service personnel.

Troubleshooting

WARNING



In following events, immediately stop operation of the air conditioner, and disconnect all the power supply by turning off the electrical breaker or disconnect the power plug. Then consult your dealer or authorized service personnel.

- As long as the unit is connected to the power supply, it is not insulated from the power supply even if the unit is turned off.
- Unit smells of something burning or emits smoke
 - Water leaks from the unit

Following symptoms do not indicate the product malfunction, but they are normal functions or characteristics of this product.

Symptom	Cause	See page
Operation is delayed after restart.	To prevent blowout of the fuse, the compressor will not operate during the protection circuit is working for about 3 minutes after sudden OFF→ON operation of the power supply.	–
Noise is heard.	<ul style="list-style-type: none"> • During the operation or immediately after stopping the air conditioner, refrigerant flowing sound may be heard. And it is particularly noticeable for 2–3 minutes after starting operation. • During the operation, a slight squeaking sound produced by the minute expansion and contraction of the front panel caused by temperature change may be heard. 	–
	During heating operation, a sizzling sound produced by the automatic defrosting operation may be heard.	4
Smell coming from the unit.	Absorbed room smell generated from interior textile, furniture, or cigarette smoke into the air conditioner may be emitted.	–
Mist or steam is emitted from the unit.	In COOL or DRY mode, a thin mist generated by condensation formed with sudden cooling process may be emitted.	–
	During heating operation, the fan built-in the outdoor unit may stops and rising steam generated by the automatic defrosting operation may be seen.	4
Airflow is weak or stops.	<ul style="list-style-type: none"> • Immediately after the heating operation is started, the fan speed stays temporarily very low to warm up the internal parts of the unit. • In HEAT mode, the outdoor unit stops and the indoor unit operates at very low fan speed if the room temperature rises above the set temperature. 	–
	In HEAT mode, the indoor unit temporarily stops for maximum of 15 minutes to perform the automatic defrosting operation while the OPERATION indicator is flashing.	4
	In DRY mode, the indoor unit operates at low fan speed to adjust the room humidity, and may stop from time to time.	–
	When the fan speed is set to "QUIET", the fan rotates at very low speed and the airflow is reduced.	–
	When monitoring operation is performed in AUTO mode, the fan rotates at very low speed.	–
Outdoor unit emits water.	During heating operation, the outdoor unit may emit water generated by the automatic defrosting operation.	–

Before you call for or request servicing, troubleshoot a problem by performing following checks:

Symptom	Diagnostic	See page
Does not operate at all.	<input type="checkbox"/> Has the circuit breaker been turned off? <input type="checkbox"/> Has there been a power outage? <input type="checkbox"/> Has a fuse blown out or the circuit breaker been tripped?	–
	<input type="checkbox"/> Is the timer operating?	3
Poor cooling or heating performance.	<input type="checkbox"/> Is the air filter dirty?	5
	<input type="checkbox"/> Is the intake grill or outlet port of indoor unit blocked?	–
	<input type="checkbox"/> Is the room temperature adjusted appropriately?	3
	<input type="checkbox"/> Is a window or door left opened? <input type="checkbox"/> Is direct or strong sunlight shinning into the room in cooling operation? <input type="checkbox"/> Are there other heating apparatus or computers operating, or too many people in the room in cooling operation?	–
	<input type="checkbox"/> Is the fan speed set to "QUIET"? When the fan speed setting is set to "QUIET", noise reduction is prioritized and the air-conditioning performance may become lower. If the volume of provided airflow is not agreeable to your preference, set the fan speed to "LOW" or higher fan speed.	3
The unit operates differently from the remote controller setting.	<input type="checkbox"/> Are the batteries used in the remote controller exhausted? <input type="checkbox"/> Are the batteries used in the remote controller loaded properly?	3

Immediately stop operation and turn off the electrical breaker in following cases. Then consult authorized service personnel.

- The problem persists even if you perform these checks or diagnostics.
- The OPERATION indicator and TIMER indicator blink while the ECONOMY indicator is blinking fast.

暖氣 & 冷氣機型

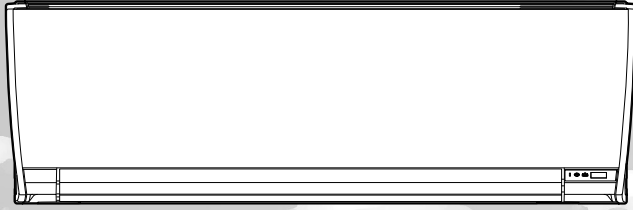

室內機組
ASWG09LMCB
ASWG12LMCB

室外機組
AOWG09LMCB
AOWG12LMCB

使用說明書

目錄

安全注意事項	Tc-1
室內機組概述與操作	Tc-2
遙控器概述與操作	Tc-3
清潔與保養	Tc-5
故障排除	Tc-7

使用本機之前，請仔細閱讀這些說明，並妥善保管本說明書，以便日後參考。

安全注意事項

為了防止人身傷害或財物受損，使用本機之前，請仔細閱讀本章節，並遵守以下安全注意事項。因未能遵守指示而引起的錯誤操作可能導致傷害或損壞，其嚴重性分類如下：



警告

此標誌表示有死亡或嚴重傷害的危險。



此標誌表示禁止行為。



注意

此標誌表示有傷害或財物受損的危險。



此標誌表示必須執行的行為。



警告

- 本機組內沒有配備用戶可自行維修的零件，請務必聯絡經授權的維修技術人員進行修理、安裝及移機。安裝或操作不當會導致漏電、觸電或火災。
- 若發生故障，如聞到燒焦味等，請立即停止空調機運轉，關閉斷路器斷開所有電源或拔下插頭，然後與經授權的維修技術人員聯絡。
- 注意不要損壞電源電纜。若電源電纜已損壞，必須由經授權的維修技術人員進行更換。
- 在製冷劑外漏的情況下，請務必遠離火或任何易燃物，並與經授權的維修技術人員聯絡。
- 如果看到閃電或聽見雷聲，可能是打雷。為了防止觸電，請在雷雨期間使用遙控器關閉空調機，且不要觸碰機組或電源插頭。
- 請勿將機組安裝在充滿礦物油、含有大量濺油或蒸氣的區域，如工廠、廚房等。
- 請勿透過插拔電源插頭或打開 / 關閉斷路器來啟動或停止空調機運轉。
- 請勿在機組附近使用易燃性氣體。
- 請勿長時間讓冷風直接吹到身上。
- 請勿將手指或其他物件插入出風口、開放面板或進風口格柵。
- 請勿用濕手操作空調機。



注意

- 使用時要不定時地進行室內通風。
- 必須裝上空氣過濾網後才能使用。
- 必須讓任何其他電子設備與室內或室外機組保持 1 米以上的距離。
- 長期不使用室內機組時請拔下電源電纜。
- 長期使用後，請檢查安裝支架是否老化，以防機組掉落。
- 如果室內有嬰兒、兒童、老年人或病人，請細心設定風向和溫度。
- 本機並非設計給身體、感覺或心智功能不足者（包括孩童）、或缺乏經驗及知識者使用，除非有能確保其安全者給予監督或指導，才能使用本機。兒童應在適當的監督下使用本機，以避免讓孩童戲玩本機。
- 請勿讓氣流直接吹向壁爐或取暖設備。
- 請勿阻塞或遮蓋進風口格柵和出風口。
- 請勿向散熱片施加重壓。
- 請勿攀爬到機組上或在其上放置、懸掛物件。
- 請勿在機組上放置花瓶或盛水容器。
- 請勿將其他任何電器或家用品放在室內機組或室外機組下方。機組滴水可能會把它們弄濕，而且可能造成財產損壞或故障。
- 請勿將機組直接置於有水的環境中。
- 請勿用於儲藏食品、動植物、精密儀器設備、藝術品或其他物件等用途，否則可能會導致這些物品變質。
- 請勿讓氣流直接吹向動植物。
- 請勿飲用空調機排出的水。
- 請勿拉扯電源電纜來拔下插頭。
- 安裝或保養機組時，請勿接觸室內或室外機組內置熱交換器的鋁片，以防止受傷。

室內機組概述與操作

1 進風口格柵

運轉開始時，請確認進風口格柵完全關閉。否則可能會影響空調機的動作或性能。

2 強制自動按鈕

萬一遙控器丟失或發生故障時，可以使用此按鈕。

狀態	動作	模式或運轉
運轉中	按住 3 秒鐘以上。	停止
停止中	按住 3 至 10 秒鐘。	自動
	按住 10 秒鐘以上。 (僅限維護中。*)	強制製冷
清潔後	按住不足 3 秒鐘。	過濾網指示燈重設

*：若要停止強制製冷，按此按鈕或遙控器上的開 / 關按鈕。

3 前面板

4 垂直風向導向板

每按一次遙控器上的 SET 按鈕，垂直風向導向板的角度按如下順序變化：

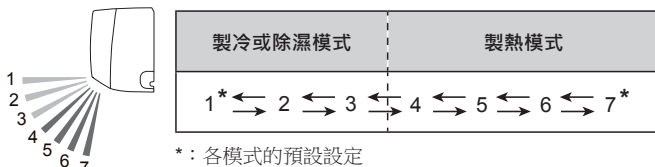

- 不要用手調整。
- 在自動或製熱模式開始運轉後，導向板可能停留在位置 1 片刻，以進行調整。
- 在製冷或除濕模式期間，如果方向設定在位置 4-7 超過 30 分鐘，導向板將自動返回位置 3。
- 在製冷或除濕模式期間，如果保持在位置 4-7，可能會導致形成凝結，且水滴可能使財物受損。

5 擴散風葉

配合垂直風向導向板的動作，擴散風葉的方向按照以下順序改變：

垂直風向導向板	1 ← 2 ← 3 ← 4 ← 5 ← 6 ← 7
擴散風葉	1 ← 2 ← 3 ← 4

- 在搖擺運轉中，擴散風葉的方向不改變。

6 排水管

7 遙控器信號接收器

注意

- 為了正常傳達遙控器與室內機組之間的信號，信號接收器應遠離：
 - 直射陽光或其他強光
 - 平面電視螢幕
- 在有螢光燈（倒相螢光燈等）的房間內可能無法接收到信號。在此情況下，請諮詢您購買產品的商店。

8 省電指示燈（綠色）

省電運轉時亮起。

9 定時指示燈（橙色）

定時運轉時亮起，偵測到定時設定錯誤時緩慢閃爍。關於定時設定錯誤，請參閱第 4 頁「自動重新啟動功能」。

10 運轉指示燈（綠色）

正常運轉時亮起，自動除霜運轉時緩慢閃爍。

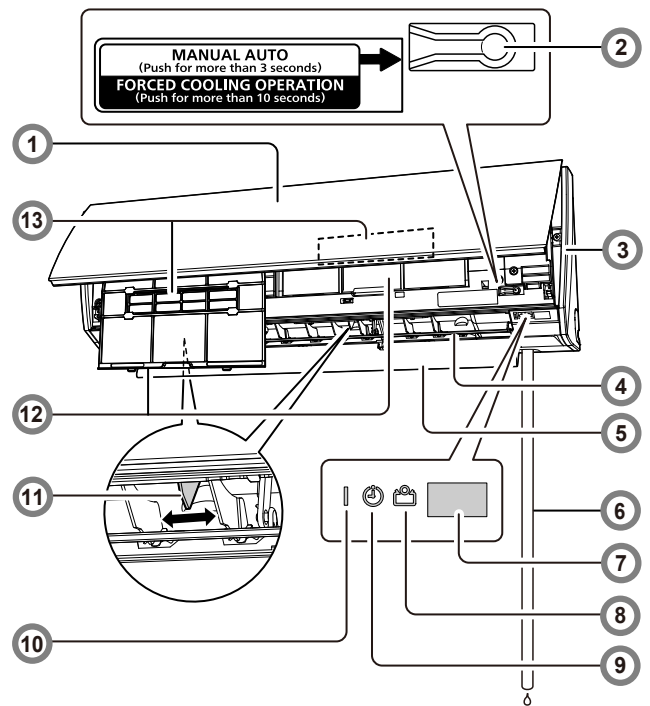

11 水平風向導向板

注意

- 調整水平風向導向板之前，確保垂直風向導向板已完全停止。
- 用手調整左右兩個調節桿。

12 空氣過濾網

請參見第 5 頁

易保養，有效抑制霉菌滋生。

13 抗菌過濾網

請參見第 6 頁

淨化或消除不良氣味，提供鮮風。

室內機組附件

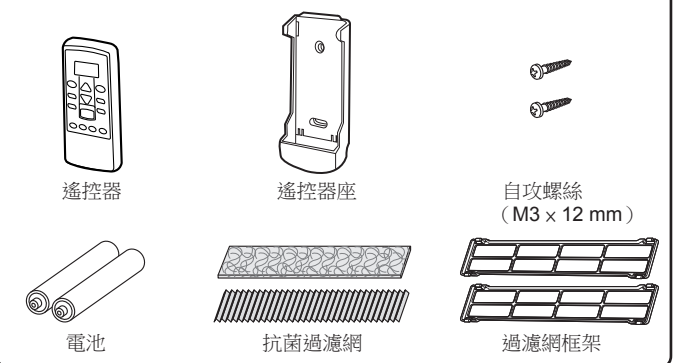

警告

- 注意不要讓嬰幼兒誤吞入電池。

安裝遙控器座

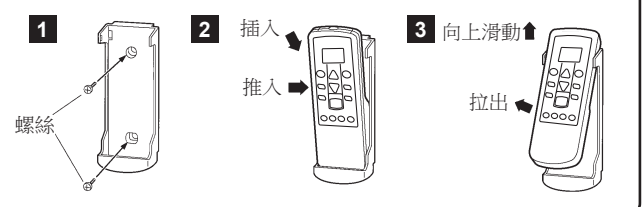

遙控器概述與操作

⚠ 注意

- ❗ 防止遙控器發生故障或損壞：
 - 請將遙控器放在不會受到直射陽光或過熱的地方。
 - 長時間不使用遙控器時，請取出電池。
 - 盡快取出電量已耗盡的電池，並根據當地法律法規進行廢棄。
- ❗ 若洩漏的電池電解液接觸皮膚、眼睛或口腔，請立即用大量清水沖洗，並儘快就醫。
- ❗ 如果遙控器與室內機組之間有窗簾或牆壁等障礙物，可能無法正確傳達信號。
- ⊘ 請勿強烈撞擊遙控器。
- ⊘ 請勿使水進入遙控器。
- ⊘ 請勿試圖對電池充電。

裝入電池 (AAA/R03/LR03 × 2)

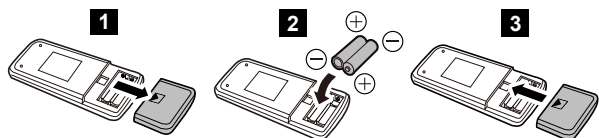

- 註：
- 僅使用指定類型的電池。
 - 請勿混用新舊電池。
 - 在正常使用條件下，電池的使用壽命約 1 年。
 - 若遙控器的有效操作距離範圍顯著變小，請更換電池，並按下 RESET 按鈕。

請按照以下 3 個步驟，快速啟動運轉：

① START/STOP 按鈕

② MODE 按鈕 * |

按照以下順序切換運轉模式。



製熱模式中的注意事項：

- 運轉之初，室內機組以極低的风速運轉約 3 至 5 分鐘，然後切換到所選的风速。
- 必要時，自動除霜運轉優先於製熱運轉。

③ SET TEMP. (溫度) 按鈕 * |

設定所需的溫度。

溫度設定範圍	
AUTO (自動)	18–30°C
COOL/DRY (製冷/除濕)	18–30°C
HEAT (製熱)	16–30°C

*：送風模式中，無法使用溫度控制。

④ FAN 按鈕 * |

控制風速。



- 選擇自動時，風速會根據運轉模式自動調整。

⑤ SET 按鈕 * |

調整垂直風向。

⑥ SWING 按鈕 * |

- 啟動或停止垂直風向導向板的自動搖擺。
- 搖擺運轉範圍因運轉模式而異，如下所示：

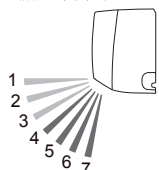

製冷或除濕模式	製熱模式
1 ↔ 2 ↔ 3	4 ↔ 5 ↔ 6 ↔ 7

- 註：
- 當室內機組風扇以極低的速度運轉或停止時，搖擺運轉可能會暫時停止。
 - 在送風模式中，根據開始搖擺運轉之前設定的風向，決定搖擺運轉範圍是 1 ↔ 3 或 4 ↔ 7。

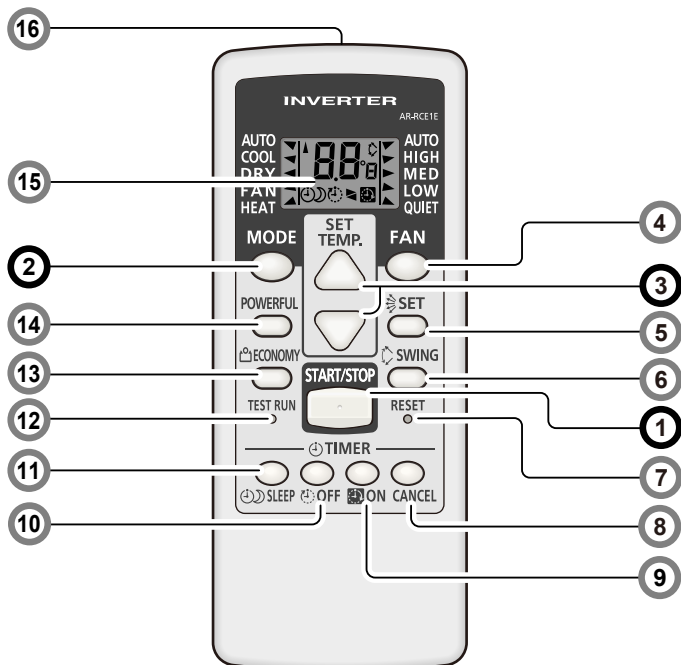

⑦ RESET 按鈕

按 RESET 按鈕時，用圓珠筆或其他細小物件按照下圖所示方向輕輕按下。



⑧ TIMER CANCEL 按鈕 * |

取消設定定時。

⑨ ON TIMER 按鈕 * |

每按一次按鈕，時間按照以下順序更改：



- 當遙控器顯示屏上的 指示燈閃爍時設定時間。

⑩ OFF TIMER 按鈕 * |

每按一次按鈕，時間按照以下順序更改：



- 當遙控器顯示屏上的 指示燈閃爍時設定時間。

*：指示燈維持亮起時，必須在約3秒鐘內完成設定。



|：只有在空調機開啟時才能控制此按鈕。

(續)

遙控器概述與操作

程序定時 (組合使用開機定時和關機定時)

可以設定開-關或關-開定時組合，如下所述：

開-關 	先設定開機定時。 然後設定定時開機運轉之後的關機定時。
關-開 	先設定關機定時。 然後設定定時關機之後的開機定時。

前一定時的倒計時結束後，設定時間較晚的定時開始倒計時。

註：

如果在設定了程序定時之後變更定時的設定值，定時的倒計時將會在此時重置。

11 SLEEP TIMER 按鈕 *

每按一次按鈕，時間按照以下順序更改：



- 當遙控器顯示屏上的  指示燈閃爍時設定時間。
若要重複定時，當未顯示指示燈時，按睡眠定時按鈕。

為了讓您睡得更舒適以及防止睡眠期間過熱或過冷，睡眠定時器會依據如下所示的設定時間自動控制溫度設定。設定時間到達後，空調機將完全關閉。

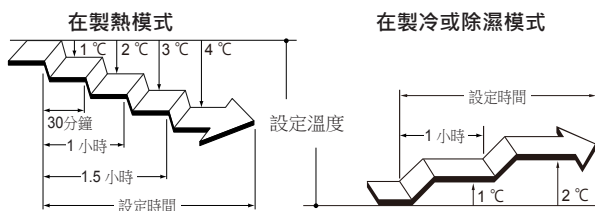

關於定時設定的注意事項：

電源中斷如斷電或切斷斷路器，會導致設定的內部時鐘不準確。在此情況下，室內機組上的定時指示燈閃爍，需要重新調整設定。

12 TEST RUN 按鈕 *

僅限用於機組安裝的初始測試。

請勿在正常使用時按下此按鈕，因為會造成誤操作。

- 試運轉期間，運轉指示燈和定時指示燈將同時閃爍。
- 若要退出不小心啟動的試運轉，必須按下 **START/STOP** 按鈕以關閉空調機。

13 ECONOMY 按鈕 *

啟動省電運轉，調整設定室溫可比其他運轉節省更多耗電量。

按省電按鈕，室內機組上的省電指示燈亮起。

- 在製冷模式中，室溫會比設定溫度略高幾度。
在製熱模式中，室溫會比設定溫度略低幾度。
- 尤其在製冷模式中，可以改善除濕而不用顯著降低室溫。

註：

- 在製冷或製熱模式中，省電運轉的最大輸出約是空調機在正常運轉時的 70%。
- 在自動模式的溫度監控期間，無法執行省電運轉。

14 POWERFUL 按鈕 *

啟動強力運轉，可讓房間快速降溫或升溫。

按此按鈕啟動強力運轉時，室內機組將發出 3 聲短嗶聲。

在以下情況下，強力運轉會自動關閉：

- 在製冷、除濕或製熱模式中，室溫達到設定溫度。
- 設定強力運轉模式後經過 20 分鐘。

在強力運轉設定期間，強力運轉不會自動關閉。

註：

- 風向和風速會自動控制。
 - 無法同時執行此運轉和省電運轉。
- 若要回復到正常運轉，再次按此按鈕。室內機組將發出 2 聲短嗶聲。

15 遙控器顯示屏

為了方便說明，在本章節中顯示所有適用的指示燈。但在實際操作時，只顯示適用於當前操作的指示燈。

16 信號發射器

將信號接收器正確對準室內機組。

- 遙控器顯示屏上的信號發射指示燈  顯示正在發射遙控器的信號。
- 有效操作距離約 7 m。
- 若發射的信號正常發出時，會聽到嗶聲。若未聽到嗶聲，再次按下遙控器上的按鈕。

自動除霜運轉

當室外溫度很低且濕度很高時，在製熱運轉過程中，室外機組上可能會結霜，從而導致空調機運轉性能下降。

為了防止這類性能下降，本空調機配有微電腦控制的自動除霜功能。

當結霜時，空調機將暫時停止，並短暫運轉除霜程序（最多 15 分鐘）。在此運轉過程中，室內機組上的運轉指示燈將閃爍。製熱運轉後，如果室外機組上結霜，室外機組會在運轉幾分鐘後自動停止，然後開始自動除霜運轉。

自動重新啟動功能

當空調機由於斷電等電源故障而停止運轉時，電源恢復後，空調機將自動按此前的模式重新啟動。

如果設定了定時之後發生電源斷電，定時的倒計時會被重置。電源恢復後，室內機組上的定時指示燈閃爍，提示您定時發生故障。在此情況下，請重新設定定時。

其他電器設備導致的故障：

同時使用其他電器設備如電動剃鬚刀或在附近使用無線電信號發射器時，可能會導致空調機故障。

在這種情況下，請先關閉斷路器，隨後再打開，然後用遙控器恢復運轉。

清潔與保養

⚠ 注意

- ❗ 清潔室內機組之前必須將其關閉，並斷開所有電源。
- ⊘ 運轉開始時，請確認進風口格柵完全關閉。否則可能會影響空調機的動作及性能。
- ⊘ 保養機組時，請勿接觸室內機組內置熱交換器的鋁片，以防止受傷。
- ⊘ 請勿使室內機組接觸液體殺蟲劑或噴髮膠。
- ⊘ 保養機組時，請勿站在打滑、不平坦或不穩定的表面上。

日常保養

清潔室內機組本體時，請注意：

- 請勿使用溫度超過 40°C 的熱水。
- 請勿使用除垢清潔劑、揮發性溶劑，如苯或稀釋劑等。
- 用軟布輕輕擦拭機組。

清潔進風口格柵

- 1 依箭頭 **a** 所示方向打開進風口格柵，輕輕向外側 **b** 按壓進風口格柵的左、右固定軸，依箭頭 **c** 所示方向拆下進風口格柵。

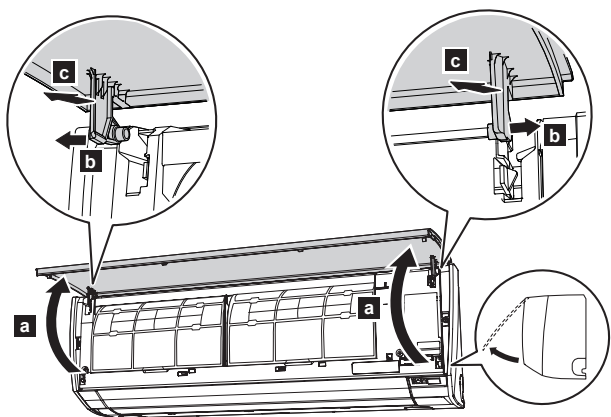

- 2 用水輕輕沖洗進風口格柵，或用沾濕溫水的軟布輕輕擦拭，然後用乾的軟布擦乾。
- 3 水平握住格柵，將左、右固定軸放入面板 **a** 頂部的枕塊。要使各軸妥善固定，插入軸直至插入到位，然後關閉進風口格柵 **b**。

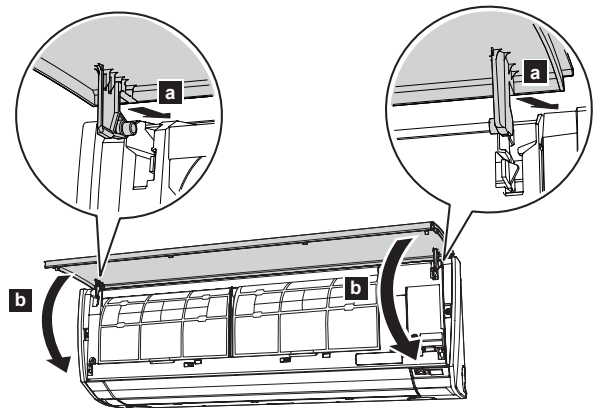

- 4 按壓進風口格柵的 4 處，以完全關閉。

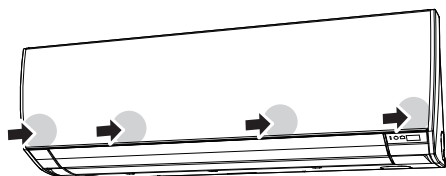

清潔空氣過濾網

請記住要定期清洗空氣過濾網，以防止產品的運轉效率降低。

使用有灰塵堵塞的空氣過濾網，不僅會降低產品性能，還會導致氣流減弱或運轉噪音變大。

在正常使用條件下，空氣過濾網必須每 2 週清潔一次。

- 1 打開進風口格柵。
(請參閱「清潔進風口格柵」步驟 1 的 **a**。)
- 2 用手握住進風口格柵，按照箭頭所示方向向上拉過濾網手柄 **a**，鬆開 2 個卡爪 **b**，然後輕輕地向下滑動過濾網，將其拉出 **c**。

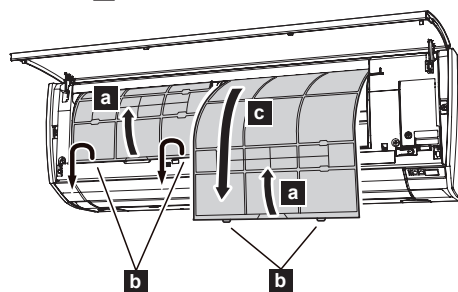

- 3 過濾網框架和抗菌過濾網已安裝在空氣過濾網反面。鬆開過濾網框架 **d** 的每個角，從空氣過濾網上拆下抗菌過濾網。

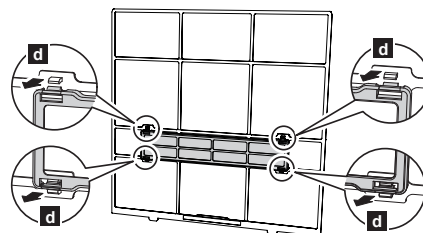

- 4 用真空吸塵機或水洗的方式清除灰塵。水洗過濾網時，請使用中性家用洗滌劑和溫水。過濾網沖洗乾淨後，先將其放在陰涼處徹底晾乾，再裝回。
- 5 將抗菌過濾網和過濾網框架安裝到各空氣過濾網。
- 6 安裝空氣過濾網時，使過濾網的兩側與前面板對齊，將過濾網完全推入。
註：
確保 2 個卡爪牢牢卡入面板的導孔。
- 7 關緊進風口格柵。
(請參閱「清潔進風口格柵」的步驟 4。)

清潔與保養

更換抗菌過濾網

- 1 拆下空氣過濾網。(請參閱「更換空氣過濾網」的步驟 1。)
- 2 鬆開過濾網框架的 2 個卡鎖 **a**，按照箭頭方向翻轉框架 **b**。拆下髒的抗菌過濾網 **c**。

註：

抗菌過濾網已安裝在各空氣過濾網上。

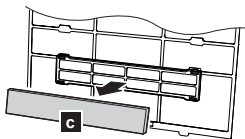
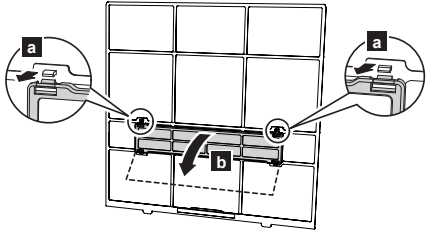

- 3 將新的或保養過的抗菌過濾網 **d** 安裝到過濾網框架。
新的抗菌過濾網可以安裝到右框架或左框架。

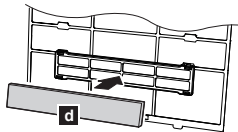

- 4 將過濾網框架的 2 個角 **e** 牢牢卡入空氣過濾網。

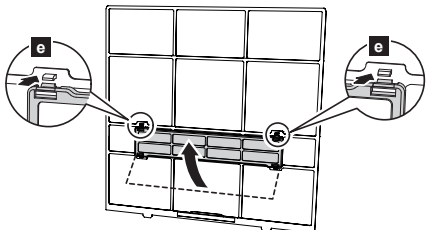

- 5 裝回空氣過濾網。(請參閱「清潔空氣過濾網」的步驟 6。)
- 6 關緊進風口格柵。
(請參閱「清潔進風口格柵」的步驟 4。)

本機使用以下 2 種抗菌過濾網。
請購買本機專用的抗菌過濾網進行更換。

蘋果茶素抗菌過濾網：UTR-FA16



(1 片)

蘋果茶素抗菌過濾網使用靜電來清潔含微粒和灰塵的空氣，例如香煙霧或看不見的花粉。

- 本過濾網屬於一次性產品。請勿清洗或重複使用。
- 包裝打開後 應盡快使用。打開包裝後，閒置不用，會降低過濾網的抗菌效果。
- 在正常使用條件下，過濾網必須每 3 個月更換一次。
- 將風速設定為高速，會增強空氣淨化效果。

負離子除臭過濾網 (發藍光)：UTR-FA16-2

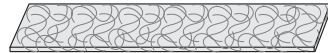

(發藍光，1 片)

本過濾網包含陶瓷超微粒，可產生具有除臭效果的空氣負離子，能吸收並緩和家中異味。

- 為保持除臭效果，請按以下方式每 3 個月清潔一次過濾網：
 1. 拆下負離子除臭過濾網。
 2. 用高壓熱水淹沒過濾網，直到過濾網表面被水覆蓋。
 3. 請用稀釋後的中性洗滌劑清洗。請勿刮擦，否則會損害除臭效果。
 4. 水流沖洗。
 5. 放在陰涼處晾乾。
 6. 將過濾網裝回室內機組。
- 在正常使用條件下，過濾網必須每 3 年更換一次。

長時間不使用機組後

如果要將室內機組關閉 1 個月以上，進行正常運轉前，請首先以送風模式運轉大約半天，使內部各部分充分乾燥。

其他檢查

長期使用後，室內機組裡面會積聚灰塵，可能會降低空調機性能。即使您按照本說明書中記載的日常保養或清潔步驟來維護本機，

我們還建議您定期檢查本機。

如需詳細資訊，請聯絡經授權的維修技術人員。

故障排除



警告



在以下情況下，請立即停止空調機運轉，關閉斷路器斷開所有電源或拔下插頭，然後聯絡經銷商或經授權的維修技術人員。
由於機組連接到電源，即使機組關閉，也並未徹底關閉電源。

- 聞到燒焦味或冒煙
- 機組漏水

以下現象並非產品故障，而是本產品的正常功能或特性。

現象	原因	參考頁
重新啟動後，無法立即運轉。	為了防止保險絲燒斷，當電源突然從關到開後，在 3 分鐘之內保護電路將發揮作用，此時壓縮機不會運轉。	-
聽見噪音。	<ul style="list-style-type: none"> • 在運轉過程中或空調機剛停止時，可能會聽到製冷劑流動的聲音。另外，開始運轉後的 2 至 3 分鐘內，噪音可能特別明顯。 • 在運轉過程中，可能會聽到輕微吱吱聲。這是由於溫度變化引起前蓋發生微小伸縮的結果。 	-
	在暖氣運轉過程中，偶爾可能會聽到嘶嘶聲。這是由於自動除霜運轉造成的聲音。	4
機組發出異味。	可能是由於房間內的織物、家具、香煙等氣味被吸入空調機後散發的異味。	-
冒煙或冒出蒸汽。	在製冷或除濕模式中，由於排出的空氣突然冷卻形成冷凝而發出淡淡的煙霧。	-
	在製熱運轉過程中，室外機組的風扇可能會停止，因此可能會看到冒出蒸汽。這是由於自動除霜運轉造成的。	4
風量較弱或停止。	<ul style="list-style-type: none"> • 當開始製熱運轉時，剛開始風速很低，以便進行讓內部零部件預熱。 • 在製熱模式中，若室溫高於設定溫度，室外機組將停止，室內機組以極低的風速運轉。 	-
	在製熱模式中，運轉指示燈閃爍時，室內機組將暫停運轉（最多 15 分鐘），以執行自動除霜運轉。	4
	在除濕模式中，室內機組以低速風速運轉以調整房間濕度，並可能不定時停止。	-
	當風速設定為「QUIET」時，風扇以極低的速度運轉，且風量減弱。	-
	執行自動模式中的監控運轉時，風扇以極低的速度運轉。	-
室外機組有水產生。	在製熱運轉過程中，由於自動除霜運轉，室外機組可能會產生水。	-

在請求維修服務之前，請先進行如下檢查：

現象	診斷	參考頁
完全無法運轉。	<input type="checkbox"/> 是否將斷路器關閉？ <input type="checkbox"/> 是否停電？ <input type="checkbox"/> 是否保險絲被燒斷或斷路器已斷開？	-
	<input type="checkbox"/> 是否定時正在發揮作用？	3
製冷或製熱性能不佳。	<input type="checkbox"/> 空氣過濾網是否變髒？	5
	<input type="checkbox"/> 室內機組的進風口格柵或出風口是否堵塞？	-
	<input type="checkbox"/> 室溫調整是否正確？	3
	<input type="checkbox"/> 門窗是否開著？ <input type="checkbox"/> 在製冷運轉時，是否有直射或強烈陽光射入房間？ <input type="checkbox"/> 在製冷運轉時，房間內是否有其他加熱設備和電腦？或有許多人？	-
	<input type="checkbox"/> 是否將風速設定為「QUIET」？ 風速設為「QUIET」時，噪音減弱功能優先，空調機性能可能下降。如果風量未能達到您的要求，將風速設為「LOW」或更高風速。	3
機組運轉與遙控器設定不同。	<input type="checkbox"/> 遙控器的電池電量是否已耗盡？	3
	<input type="checkbox"/> 遙控器的電池是否安裝正確？	

在以下情況下，請立即停止運轉，並關閉斷路器，然後與經授權的維修技術人員聯絡。

- 進行上述檢查或診斷後故障仍然存在。
- 省電指示燈快速閃爍時，運轉指示燈和定時指示燈閃爍。

